

**Small Size,
Big Coffee.**

IB7

The perfect coffee

by Blai Farré

Understanding every part of the machine and listening to every customer is the only way to create machines that work not as machines, but as tools.

Entender cada pieza y escuchar a cada cliente es la única manera de crear máquinas que funcionen no como máquinas, sino como herramientas.

THE
BARCELONA
SPIRIT



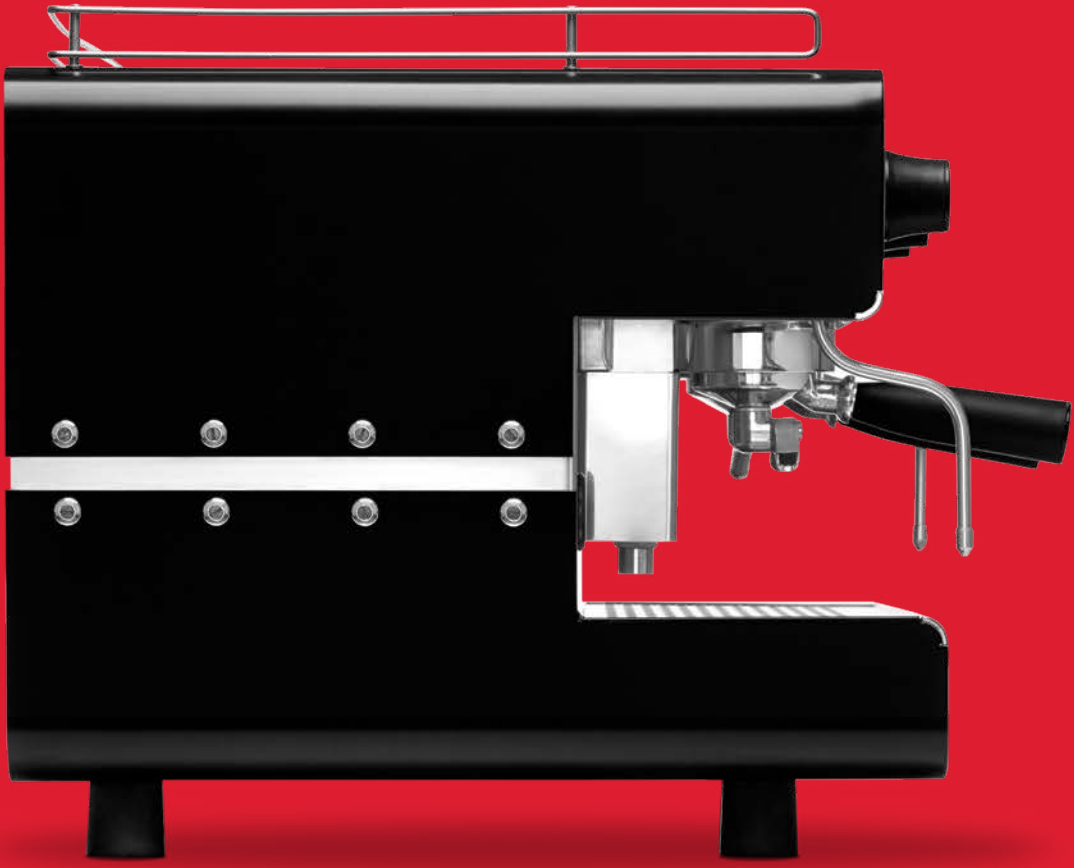

Small Size, Big Coffee.

The new IB7 is the perfect machine for small spaces. A smart choice for great coffee.

La nueva IB7 es la máquina perfecta para espacios pequeños. Una sabia elección para un café fantástico.

The IB7 has been created to make the perfect coffee in a limited space. A machine with a smart, compact design that retains the robustness and durability of all Iberital products. The missing piece of the puzzle that fits perfectly into your bar.

La IB7 está creada para hacer el mejor café en un espacio reducido. Una máquina que ha sido diseñada de forma inteligente para distribuir y ensamblar piezas en un formato más comprimido, manteniendo la solidez y la sostenibilidad de un producto Iberital. Completa el puzle de tu bar con la pieza que encaja perfectamente.

A unique design based on vintage machines. Strong & beautiful.

Un diseño único basado en las máquinas antiguas. Resistentes y atractivas al mismo tiempo.

The IB7's design embodies the vision of a classic 20th century espresso machine and combines this image with a technologically advanced model built from durable materials and stainless steel panels. Whether you're unpacking your machine for the first time or carefully ensuring its upkeep, the IB7 offers a unique experience that fuses ergonomics with smart design.

El diseño de la IB7 toma como referencia las líneas que dibujaron las clásicas máquinas espreso del siglo XX y las aplica en un modelo tecnológicamente avanzado compuesto de materiales sólidos y frontales inoxidable. Desde el desembalado hasta el mantenimiento se trata de una experiencia única en términos de ergonomía y diseño inteligente.



“The secret of a perfect coffee is a reliable machine”

“El secreto de un café perfecto es una máquina de confianza”



Carlos Moral, Barista.

Official Trainer authorized by SCAE. Iecafé.
Formador oficial autorizado por SCAE. Iecafé.

1G

1 GROUP

Less than 200 kg
of coffee per year.
*Menos de 200 kg
de café al año.*

6L

2G

2 GROUPS

From 200 to 300 kg
of coffee per year.
*De 200 a 300 kg
de café al año.*

10,5L

3G

3 GROUPS

More than 500 kg
of coffee per year.
*Más de 500 kg
de café al año.*

20L

Functional, Reliable, Powerful & Smart

Funcional, fiable, potente e inteligente

Touch pads / Botoneras

Stylish and back-lit.
Elegantes y retroiluminadas.

Stainless steel front panel / Panel frontal de acero inoxidable

Made of glossy-finish
stainless steel.
*Hecho de acero inoxidable
con acabado satinado.*

Gauge / Manómetro

The right pressure,
extraordinary steaming.
*Una presión adecuada, una
erogación extraordinaria.*



Control / Mando

Hot water control with anti-splash.
Mando de agua caliente con antisalpicaduras.

Filter holder / Portafiltro

Ergonomically tilted.
Ergonómicamente inclinado.

Cup warming grid / Rejilla caliente tazas

Removable plastic grid.
Rejilla de plástico extraíble.

Stainless steel front panel / Panel frontal de acero inoxidable

Made of glossy-finish stainless steel.
Hecho de acero inoxidable con acabado satinado.

Steam pipes / Tubo de vapor

Adjustable and easy to clean.
Ajustable y fácil de limpiar.



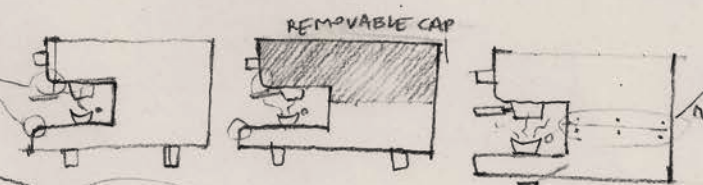
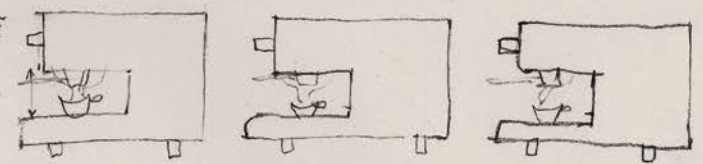
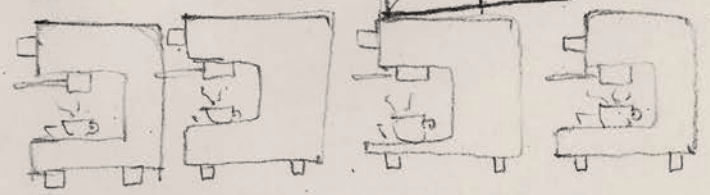
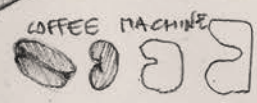
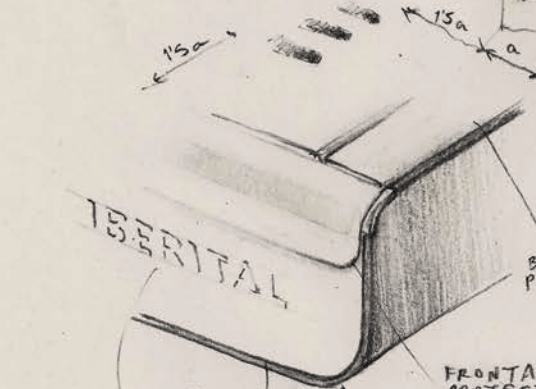
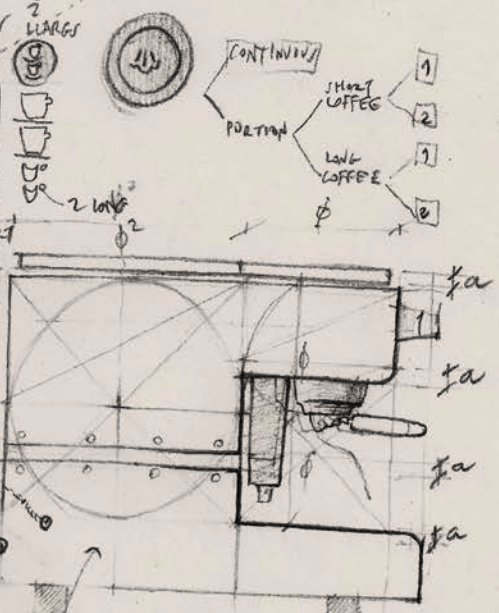
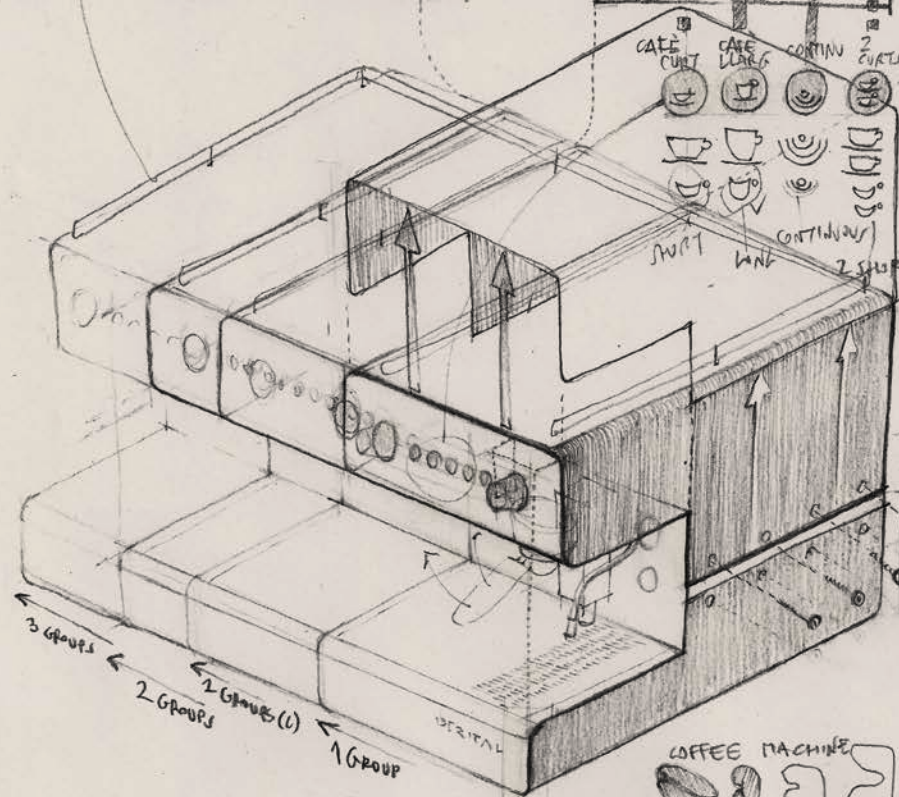
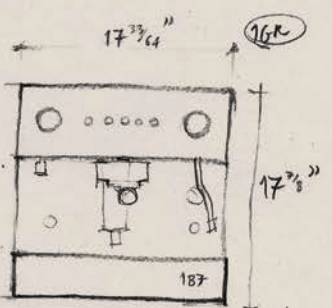
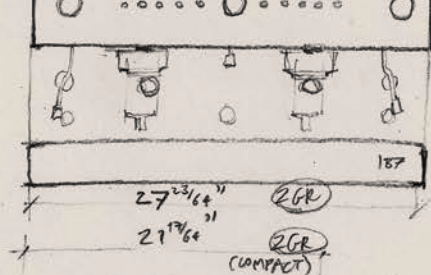
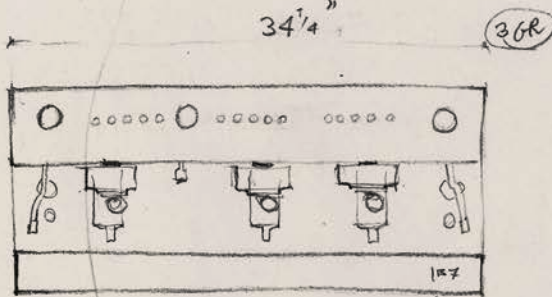
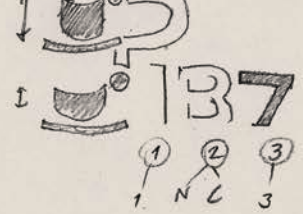
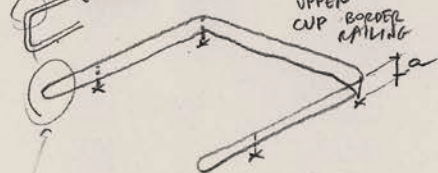

THE BOARD MUST BE SHOWN MORE CLEARLY

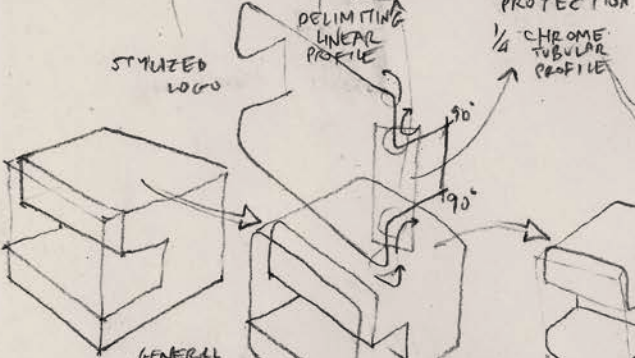

AVOIDING CORNER (!)

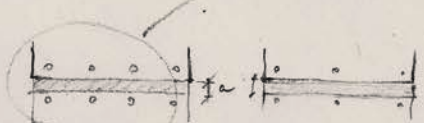

The IB7 has outstanding features to make every coffee an experience

La IB7 tiene unas características que te harán sentir una experiencia más allá de tu café

TECHNICAL SPECIFICATIONS / CARACTERÍSTICAS TÉCNICAS

Adjustable touch panel settings.
Programación de las dosis de los cafés.

Boiler capacities / Capacidad Caldera:
1GR: 6L · 2GR: 10,5L · 3GR: 20L

Heating element / Resistencia eléctrica:
1GR: 1.800W · 2GR: 3.000W · 3GR: 5.000W

Stainless steel steam pipes.
Tubos de vapor en acero inoxidable.

Anti-splash hot water outlet.
Salida de agua caliente anti-salpicaduras.

Automatic boiler fill.
Llenado automático de agua de la caldera.

Heating element protector device.
Protector de resistencia incluido.

Internal motor and pump.
Motor bomba incorporado.

Weight / Peso:
1GR: 37Kg · 2GR-C: 54Kg · 2GR: 61Kg · 3GR: 79Kg

DIMENSIONS / DIMENSIONES

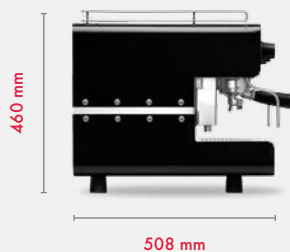

Iberital, the coffee universe

Coffee machines / Máquinas de café



Expression Two

Form and function in its maximum expression.
Estilo y funcionalidad en su máxima expresión.



New Iberital

Technologically advanced, powerful and stylish.
Tecnológicamente avanzada, potente y elegante.



IB7

Smart and stylish design for any space.
Diseño inteligente y elegante para cualquier espacio.



Stila

Iberital's open capsule system.
El sistema abierto de cápsulas de Iberital.

Listening to each and every customer is the only way to create machines that work

Escuchar a cada cliente es el único camino para crear máquinas que funcionen

● Basic ● Medium ● Premium



Intenz

Intensity in every part, intensity in every coffee.
Intensidad en cada pieza, intensidad en cada café.

Spare Parts

Iberital has spare parts for all of their machines and delivers them around the world in 24 or 48 hours.

Iberital dispone de recambios para cada una de sus máquinas y las envía alrededor del mundo en 24 o 48 horas.

Technical assistance

Iberital has expert engineers on hand to provide immediate assistance.

Iberital dispone de ingenieros expertos a plena disposición para asistencia inmediata.

☎ + 34 93 632 64 55

✉ sat@iberital.com



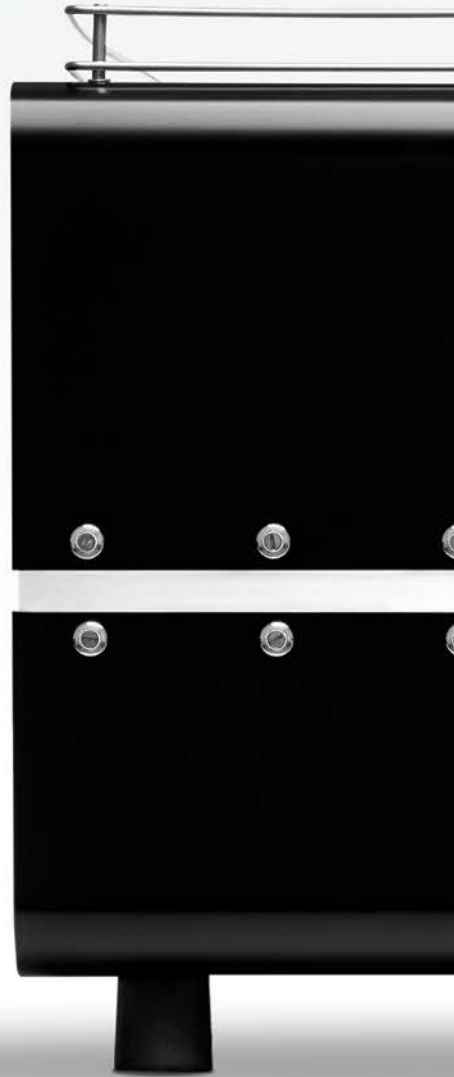

Designed and hand made at our factory in Barcelona

All Iberital machines have been conceived, designed and produced by hand in Barcelona. From the very first design to the finishing touches of their assembly.

Todas las máquinas de Iberital han sido conceptualizadas, diseñadas y fabricadas a mano en Barcelona. Desde las primeras líneas que dibujan el boceto hasta la última pieza en el ensamblado.

It all begins with the barista, and their skills behind the bar. What the barista needs and cares about.

A barista doesn't want a machine, but customers who are happy with their coffee. And that's why Iberital doesn't only deliver an outstanding machine, but a tool that goes everywhere with the barista.

Working like a tool means always working and working fast. IB7, the perfect tool.

Todo empieza en las manos del barista, en cómo se organiza detrás de la barra. En lo que necesita y lo que le preocupa.

Un barista no quiere una máquina, quiere clientes contentos con su café. Y por eso Iberital no solo entrega una máquina que no falla, sino una herramienta que acompaña.

Funcionar como una herramienta significa funcionar siempre y rápidamente. IB7, la herramienta perfecta.